

Mustang SkidSteer Loader 2054

Technical Specifications

ENGINE SPECS

Make	YANMAR	
Model	4TNV88	
Displacement	133.6 cu. in.	(2.19 L)
Number of Cylinders	4	
Rated Net Power Output	47 hp	(35 kW) @ 3000 rpm
SAE-Rated Torque	103 ft. lbs.	(140 Nm) @ 1200 rpm
Max. Axle Torque	5800 ft. lbs.	(7864 Nm)
Fuel Tank	14.3 gal.	(54.1 L)

ELECTRICAL SYSTEM SPECS

Battery Power	12 volt
Cold Cranking Amps	700 amp

HYDRAULIC SYSTEM SPECS

Std. Auxiliary Hydraulics	18.5 gpm	(70 L/min)
Optional Hi-Flow Auxiliary Hydraulics	28 gpm	(106 L/min)
Working Pressure	3000 psi	(207 bar)
Hydraulic Tank Refill/System Total	11.5/13 gal.	(43.5/49.2 L)

CAPACITIES / PERFORMANCE SPECS

SAE Breakout Force - Lift	4400 lbs.	(19.5 kN)
SAE Breakout Force - Tilt	5000 lbs.	(22 kN)
SAE Rated Operating Load	1650 lbs.	(748 kg)
SAE Rated Operating Load w/ Optional Weight Kit	1750 lbs.	(794 kg)
Tipping Load	3300 lbs.	(1497 kg)
Lifting Arm	Radial	
Travel Speed	0 - 7.2 mph	(0 - 11.5 km/h)
Optional Travel Speed	N/A	

UNDERCARRIAGE SPECS

Wheel Base	(F)	38.5"	(978 mm)
Ground Clearance	(I)	7.5"	(191 mm)

DIMENSIONS / WEIGHT SPECS

Operating Weight		6050 lbs.	(2744 kg)
Length - with Bucket	(H)	122.5"	(3112 mm)
Specified Height	(R)	61.5"	(1562 mm)
Overall Height - Top of ROPS	(K)	77.7"	(1973 mm)
Clearance Circle - Front (w/o Bucket)	(M)	45.7"	(1161 mm)
Clearance Circle - Front (w/ Bucket)	(Q)	74.5"	(1892 mm)
Clearance Circle - Rear	(N)	59.2"	(1504 mm)
Rollback Angle at Ground Level	(E)	28°	
Departure Angle	(J)	27°	
Reach at Specified Height	(S)	33.6"	(853 mm)
Width w/o Bucket (10 x 16.5 HD Tires)	(O)	60.4"/65.7	(1534/1668mm)
Length w/o Bucket	(G)	96.8"	(2459 mm)
Width Over Tires		60.4"	(1534 mm)
Height to Hinge Pin	(A)	115"	(2921 mm)

DUMPING CAPACITY SPECS

Dump Height	(B)	92"	(2337 mm)
Dump Reach	(C)	24"	(610 mm)
Dump Angle at Full Height	(D)	34°	

BUCKET SPECS

Width	(L)	61.5"	(1562 mm)
Self-Leveling Bucket		Optional	
Reference Bucket Capacity		13 cu. ft.	(368 L)

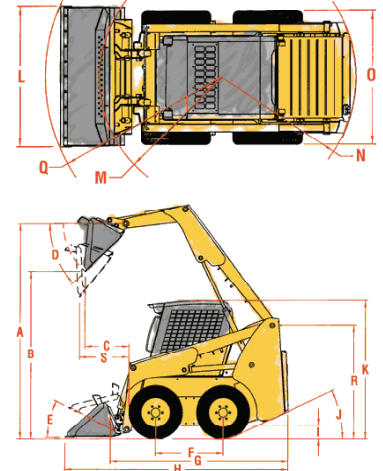

1880 Austin Road
 Owatonna, MN 55060-0547
 Phone: 507-451-7112
 Fax: 507-451-8209
 www.mustangmfg.com